



VORTEX 4

F#%K the lights.

ENTER THE VORTEX 01

Introducing the Vortex4, the latest fixture in the Creamsource Vortex series.

We continue to Redefine Nothing. We love seeing you, our users, doing all the redefining - and now is the time that we add another tool into your creative tool kit.

The Vortex4 is a 325W high powered LED system in a 1x1 format. This fixture shares many key elements of its predecessor Vortex8, including the narrow native beam angle of 20° and the evolving CreamOS Operating System.





VORTEX4 OVERVIEW 02

The Vortex4 is a 1x1 RGBW all-in-one lighting system with integrated power supply and antennas. A punchy 20° beam gives a reading of 7,300lux @3m. This fixture has a CCT range from 2200K to 15000K and four independently controllable zones. Vortex can be used as a hard light or soft light with the Creamsource Diffuser or Dome.

Effects, colour gels and our latest 'FrameSync' technology are built into the latest CreamOS architecture. Like it's big brother, Vortex4 has no problem with bad weather, messy effects machines or extreme dust. The Vortex4 is IP65 water resistant and sealed for the ultimate security and efficiency.

Vortex4 adopts 'Vortex Connect' including LumenRadio TimoTwo built in, Ethernet with sACN, Bluetooth, Wifi, 5pin DMX, USB type A and Creamsource Accessory port, enabling a plethora of control possibilities and future protocol support. New rigging points have been built into Vortex4 to accommodate rapid rigging of large arrays of units. Battery powered operation is also supported with a dedicated 48V DC input.

We stand by our users offering 5 years Warranty when you register your product. Go to www.creamsource.com for more information.



 **ORTEX** 4



IP65 WATER RESISTANT 03

The Vortex4 is built and designed to withstand all weather conditions and is rated IP65. The Vortex4 is an ultra-quiet fan-based system with optimum thermal efficiency. The fan system and heatsink placement allows for core electronics to be sealed and isolated. This ensures the ultimate safety and piece of mind when operating in volatile conditions or heavy effects environments.

Only premium waterproof connectors have been used in this series allowing all functions to be used in all weather conditions.

325W OF PUNCH 04

The Vortex4 is a 325W hard light with a beam angle of 20°. This 1x1 fixture gives the meter a workout, reading 7,300 lux at 3m / 9.8ft. Similar to the output of a 575W HMI equivalent.

The versatility of a narrow beam source is obvious. Both the artistic and technical needs to diffuse or shape the beam, create the flexibility needed to perform a range of tasks and provide a number of different lighting aesthetics.





MODERN CREAMOS 05

The Vortex Series has been built with new software architecture at its base, supporting a myriad of new features, protocols and connectivity mediums making the future evolution of CreamOS very exciting.

Such evolution has come to fruition with a number of recent innovations in the space including the all-new FrameSync and like the Vortex 8, multizone control is also available with 4 zones on the Vortex4.

All of these evolving functions are wrapped into a new user interface, enhancing the user experience.

F#%K the rain.



IP65

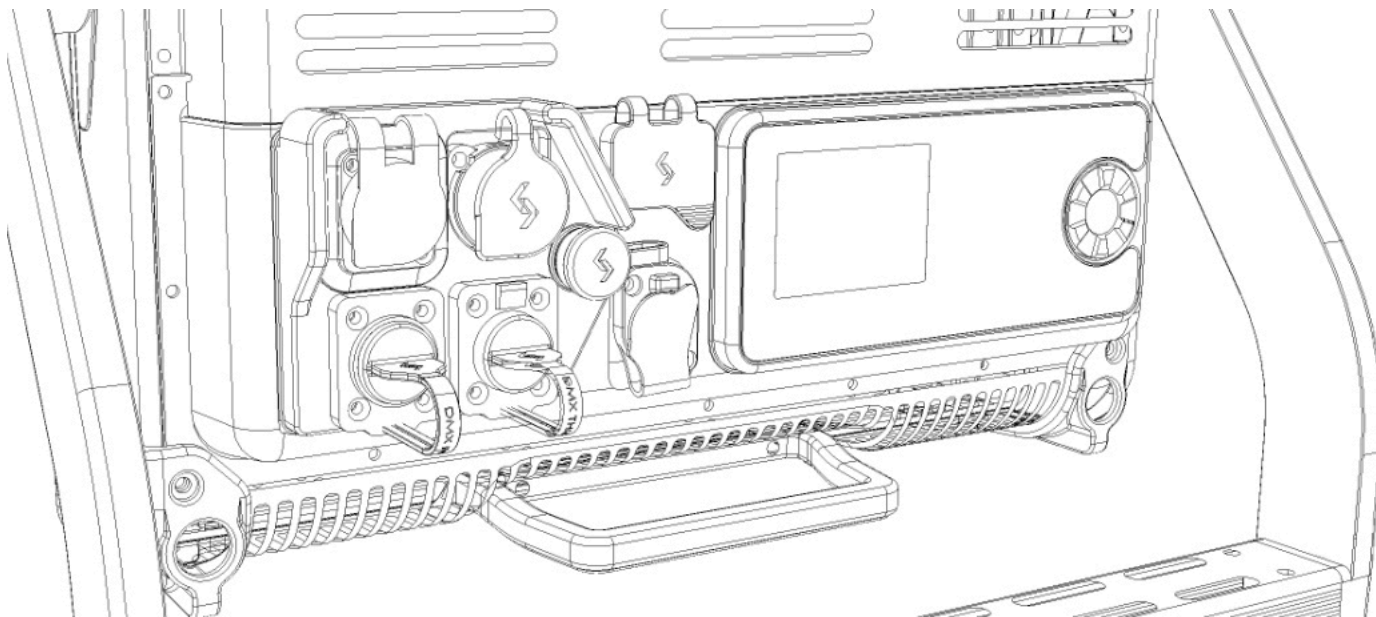

ADVANCED CONNECTIVITY 06

Interfacing with 3rd party equipment, apps and the internet is possible across the Vortex series.

LumenRadio TimoTwo, Ethernet, Bluetooth, 5pin DMX, Wifi, USB typeA and Creamsource Accessory port are all available on the antennaless Vortex4 offering endless potential communication and remote control.



PHOTOMETRIC NAKED 20°

3200K

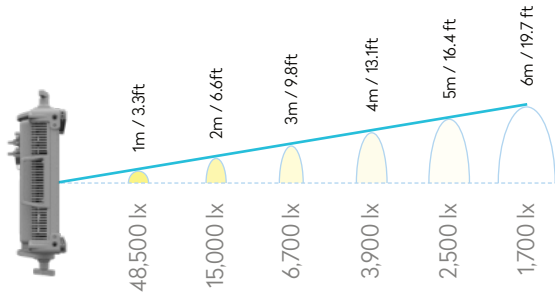

SPECTRUM

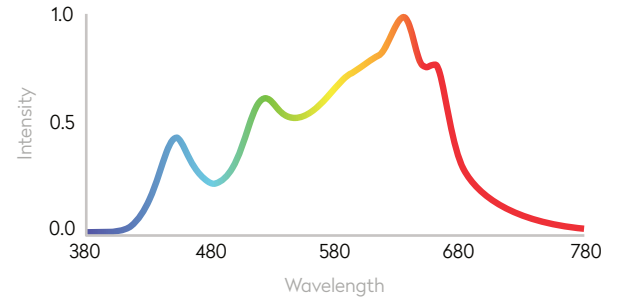

5600K

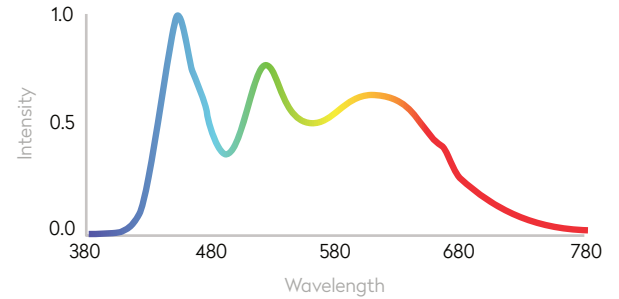
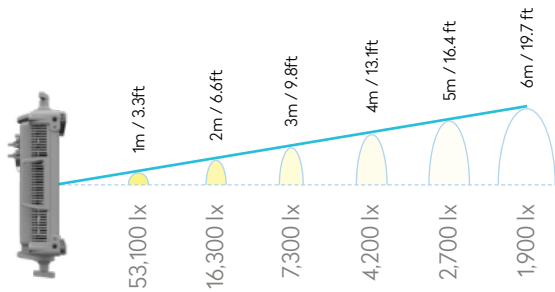

OVERVIEW

3200K

CRI 97.0
CRI (Re) 96.2
TLCI 94.0
CQS 95.7
Rf 94.9
Rg 103.3

COLOUR QUALITY

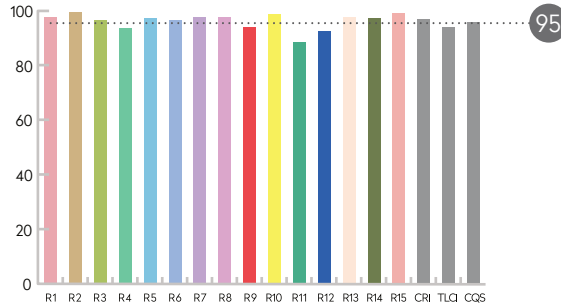

COLOUR VECTOR

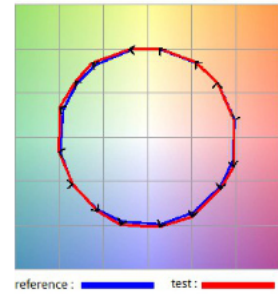

5600K

CRI 95.3
CRI (Re) 93.9
TLCI 96.4
CQS 96.3
Rf 93.1
Rg 103.4

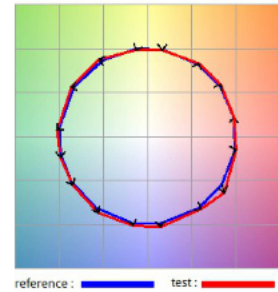
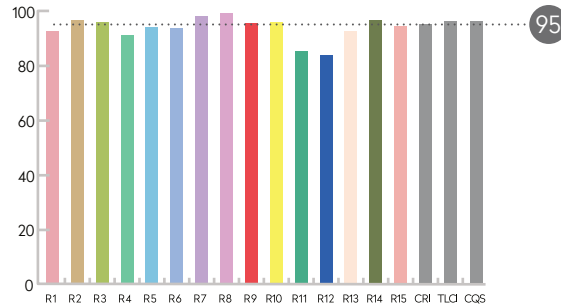



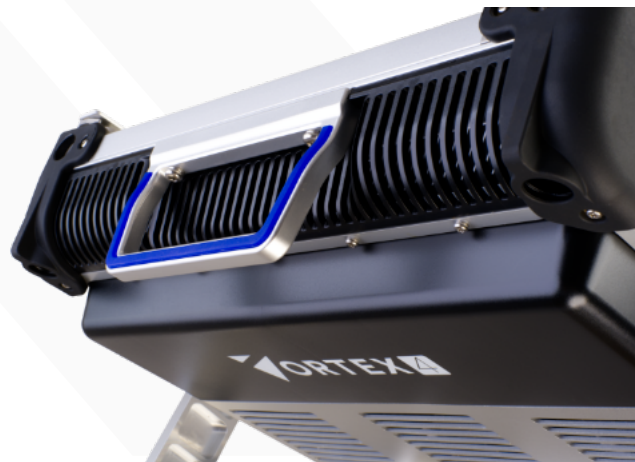
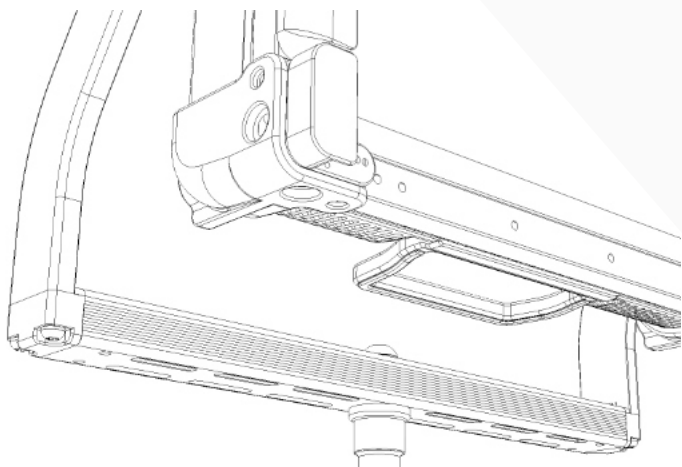

OUR DESIGN 09

Our design team spend endless hours experimenting with new technologies, techniques and materials to maximise the quality and the efficiency of the Creamsource experience.

The Vortex4 is no different. As Vortex8 puts a steak in the ground as a household name, we can't help but think about the things we can do to improve the Creamsource products. Such improvements can be seen in the growth from Vortex8 to Vortex4.

Not only is it our goal to make our lighting fixtures perform to the highest standards, we also strive to achieve our own artistic standards.

ORTEX SERIES

ORTEX 8
650W



ORTEX 4
325W

VORTEX4 SPECS 10

Material	Aluminium/Technopolymer
Light Source	RGBW LED
Colour Range	CCT: 2200 - 15000K, PLUS/MINUS GREEN, HUE/SATURATION, XY, GELS, DIRECT RGBW, EFFECTS
CRI	Typical 95
TLCI	Typical 95
Beam Angle, SPOT Lens	20° (Half Peak Angle)
Tilt Angle	360°
Photometrics	3200K: 48,500 lx / 4,507 fc @ 1m / 3.3ft 15,000 lx / 1,394 fc @ 2m / 6.6ft 6,700 lx / 623 fc @ 3m / 9.8ft 3,900 lx / 362 fc @ 4m / 13.1ft 2,500 lx / 232 fc @ 5m / 16.4 ft 1,700 lx / 158 fc @ 6m / 19.7 ft 5600K: 53,100 lx / 4,935 fc @ 1m / 3.3ft 16,300 lx / 1,515 fc @ 2m / 6.6ft 7,300 lx / 678 fc @ 3m / 9.8ft 4,200 lx / 390 fc @ 4m / 13.1ft 2,700 lx / 251 fc @ 5m / 16.4 ft 1,900 lx / 177 fc @ 6m / 19.7 ft
Mounting	8x 3/8" Threaded Insert Rigging Points
Yoke	Removable quick release yoke
Filter Rails	2 Filter Rails for Secondary Lenses, Diffusers, Accessories
User interface	High Precision Digital Magnetic Encoder, Backlit Keypad, Colour LCD Display
Dimming	0-100% with High Resolution, Super-Smooth Low End Mode

High Speed Capability	Over 5000fps Flicker Free in High Speed Mode
Synchronization	Sync Input for Triggering and Syncing to Camera Shutter
Max Ambient Temperature	40°C
Cooling	Low noise variable speed fans
Estimated LED Lifespan	50,000hrs (L70)
Input (AC)	100-240V AC, 50/60Hz, Max 3.3A. Neutrik PowerConTrue connector
Input (DC)	48V DC, Max 6.9A, Can run at 100% brightness on DC input
Protection Class	IP65
Weight	9.76kg / 21.5lb (Excluding Yoke) 1.64kg / 3.6lb (Yoke weight)
Dimensions	380 x 380 x 121mm / 15" x 15" x 4.8" (Excluding Yoke) 525 x 570 x 179.25mm / 20.7" x 22.4" x 7.1" (Including Yoke)
Warranty	3 Years on Fixtures, 12 Months on Accessories (5 Years registered)
Certifications	Pending: CE, ETL and FCC
Control	On-Board Interface, DMX via standard 5-pin XLR connectors, Wired Remote Control Accessory, Integrated Lumen radio Timo Two with Bluetooth, Ethernet, USB Type A
Includes	Vortex4 325W Colour, Yoke, Power cable, Flat diffuser
Product Code	K-CSV-4-ESS



CREAMSOURCE

Outsight Pty Ltd
2/49 Carrington Road
Marrickville, NSW 2204
AUSTRALIA

SALES HOTLINE

TEL (SYD): +61 2 9699 8688
TEL (USA): +1 818 748 8401
sales@creamsource.com
www.creamsource.com