

SUPER LED F7

160W LED Fresnel SPOTLIGHT 90-240V 50-60 Hz

(white light, either Tungsten or Daylight balanced Correlated Color Temperature)

INSTRUCTION MANUAL



MANUFACTURER



REPRESENTATIVE

ILT Italy S.r.l.

Via Cancelliera # 10a, 00041 Albano Laziale (Rome- Italy).

Tel. +39/06/902901 Fax. +39/06/90231051

U.R.L.: www.desisti.it E-mail: desisti@desisti.it

1. INTRODUCTION

Congratulations on your purchase of a SUPER LED F7 lighting fixture.

Our commitment to Total Customer Satisfaction and our consolidated experience and leadership in design innovation and manufacturing of lighting products for the professional Entertainment Industry means you can depend upon the quality of this product.

The SUPER LED F7 is a compact, highly efficient Fresnel lens spotlight using a LED ARRAY combined with the DE SISTI Patented optical system to optimize the photometric performances of LED ARRAYS when utilized in combination with either Fresnels or Plano Convex lenses.

The Lighting Fixture is DMX Controlled and includes a number of parameters that can be set locally, it is equipped with 90-240V 50-60 Hz power supply for AC feed and it is available with either

Tungsten or Daylight Balanced CCT.

It utilizes Standard accessories from the DE SISTI range of equivalent Fresnel Lens size, such as Barndoor, Colour Frame, Cones, scrims.

2. POWER AND DMX DAISY CHAIN



The SUPER LED F7 permits both POWER and DMX DAISY CHAIN. In fact each Fixture is respectively equipped with:

For DMX:

- 1 XLR5 pin Panel Mount Male (DMX IN)
- 1 XLR5 pin Panel Mount Female (DMX OUT)

For Mains Supply

- 1 20A Powercon NAC3MPA BLUE (POWER IN)
- 1 20A Powercon NAC3MPB WHITE (POWER OUT)

It is recommended to Daisy Chain a Max of 10 fixtures, even if the limitations imposed by DMX Standards are for an higher q.ty of units and even if the Powercon Connections are rated for 20A max.

3. SAFETY INSTRUCTIONS

⤿ **Professional use:** This luminaire has been designed for professional use and must be operated by qualified personnel only. **Not for residential use.**

⤿ **Grounding: WARNING: THIS LUMINAIRE MUST BE GROUNDED**

⤿ **WARNING:** Disconnect Power CORDS before any maintenance work or opening the FUSE HOLDER. Risk of serious injury.

⤿ **Electrical connections: IMPORTANT** The cores in this mains lead are colored in accordance with the following code:

	<u>Europe</u>	<u>America</u>
Ground	Green & yellow	Green or green & yellow
Neutral	Blue	White
Live	Brown	Black

In case the colors of the cores do not correspond to the colors of the connection points on your plug, please proceed as follows:

- the green or green and yellow core must be connected to the connection point marked with the letter ⏏ with the symbol ⏏ or colored in green or in green - yellow;
- the blue (or white) core must be connected to the connection point marked with the letter N or colored in black;
- the brown (or black) core must be connected to the connection point marked with the letter L or colored in red.

Working conditions

⤿ Working Position	Lighting fixture: Max. Tilting $\pm 90^\circ$ from horizontal			
⤿ Ambient Temperature, t_a at the place of installation and Storage	Minimum 10°C , maximum $+40^\circ\text{C}$			
⤿ Humidity at the place of installation and Storage	25-80% (not condensing)			
⤿ Minimum distances from inflammable surfaces	Top	Back	Sides	Front
	0,2 m.	0,1 m.	0,1 m.	0,75 m.

The luminaire should never be OPERATED close to inflammable materials. The ones indicated in the

above table are the minimum distances recommended. Other requirements for safe use are:

- A. Do not cover the apertures of the luminaire housing. They are essential for correct ventilation.
- B. Use only original accessories and spares from De Sisti Lighting.
- C. Before hanging the luminaire ensure that the suspension point (or the stand) is properly rated to accept the luminaire weight.
- D. In case of pole operated use, fit only a P.O. stirrup from De Sisti Lighting.
- E. A suitable secondary safety suspension device (safety cable, chain or equivalent) must be fitted between the suspension point and the eyelet at the front of the body .

WARNING : DO NOT MOUNT THE LUMINAIRE ON A NORMALLY FLAMMABLE SURFACE .

4. INSTALLATION INSTRUCTIONS

The following procedure should be adopted:

Before connecting the luminaire to the electrical mains ensure that:

- A. Earth line is present on the power socket.
- B. The mains voltage is within the rated range of the luminaire (see technical data on the rating label)
- C. The front safety shield is present and in good condition.
It consists of a Fresnel lens made by borosilicate un-toughened glass, with a Diameter = 175 mm , thickness = 5 mm type (3 min).



WARNINGS :

- Do not operate the product if the ambient temperature exceeds 40° C
- Provide a minimum clearance of 0,1m (4 in.) around fans and air vents.
- SHIELDS, LENSES SAFETY OR DICHROIC GLASSES SHALL BE CHANGED IF THEY HAVE BECOME VISIBLY DAMAGED TO SUCH AN EXTENT THAT THEIR EFFECTIVENESS IS IMPAIRED, FOR EXAMPLE BY CRACKS OR DEEP SCRATCHES.
- THE LUMINAIRE SHALL ONLY BE USED COMPLETE WITH ITS PROTECTIVE SHIELD

D. Applying power:

Never connect to dimmer power. Install a power plug on the power cable using the following pin assignment:

1 : Neutral 2 : Live Green/Yellow : Ground - This fixture must be connected to ground.

Make sure the local power voltage is within the range specified. If so; connect the power cable and turn the power on.

E. Stand Alone operation:

Using the navigation buttons and display readout (refer to the "Local Menu" chapter) navigate to Manual and set the desired intensity (for additional operations see "Local Menu" chapter)

F. DMX operation:

Connect a DMX cable

Navigate to Address mode (Addr) and set the desired address, (refer to the "Local Menu" chapter). Connect to DMX controller (refer to the "Channel Setting" in the "Local Menu" chapter) and Use it.

5. LOCAL MENU

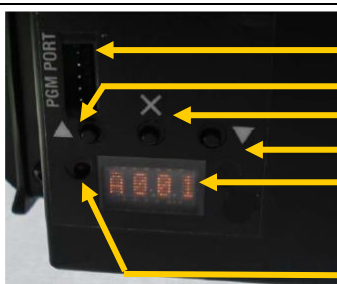

PGM PORT

For Firmware Upgrade

▲ FUNCTION 1

Scrolling UP / Increases value "function key"

ENTER

Select / Confirm

▼ FUNCTION 2

Scrolling DOWN / Decreases value "function key"

Display

When the push button are not used for more than 15 seconds the display will go OFF. It will go ON again anytime a push button is activated.







DMX Presence







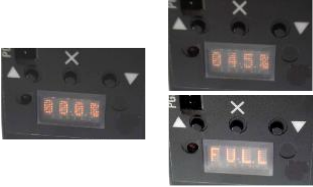



Shows the presence of DMX (LED lit = DMX present)

DEFAULT SETTINGS ARE INDICATED IN BOLD LETTERS ON THE FOLLOWING TABLE:

The following are the BASIC FUNCTIONS and COMMANDS that are provided on the LOCAL MENU of the LED

FRESNEL. The unit is provided with a USER MENU accessible instantly on the product.
 The unit has also a SERVICE MENU that is only accessible through a PASSWORD and is reserved for QUALIFIED and TRAINED PERSONNEL:

1st MENU Displayed (scrolling with the ▲ and the ▼ buttons)	2nd MENU Displayed (after pressing the X that stands for ENTER)	Explanation of Each MENU FUNCTION
		<p>DMX ADDRESS</p> <p>This Function is to SET the DMX address from 1 to 512 (Product is delivered with default setting of the DMX address at 1) Once the C001 is displayed, act on the ▲ button to increase the address to the desired value. Temporary push will increment the value by 1, if the button is kept pushed the increment on numbers is getting fast. Once the desired Address number is accomplished press X ("ENTER") to make it active</p>
 		<p>LOCAL DIMMING CONTROL</p> <p>This Function is to LOCALLY DIM the LED INTENSITY from 0 to 100% (Product is delivered with default setting of the DIMMER at 0) moving a Potentiometer control. The intensity goes in increments of 1/100% so the display will show 000% with the dimmer at 0% and FULL with the dimmer at 100%. Once the desired Lighting Level is accomplished moving the Potentiometer control and it is wanted to leave that level and go to other functions of the MENU, press "ENTER".</p>
		<p>LOCAL OR REMOTE CONTROL SETTINGS</p> <p>The LED Fresnel has the facility to block the LOCAL DIMMING SETTING and maintain it when the POWER is turned first OFF and than ON again. This allows for the LIGHT to be TUNED and FOCUSED locally and its dimming level can be blocked, so that for instance a system lighting a SET can be operated by a remote switch or simple brakers by TURNING POWER ON. The relevant menu to access this function is CTRL, to enter in this menu press X ("ENTER"), it is than possible to select either DMX or AUTO by acting on the ▲ or ▼ button and than press X ("ENTER") again. The machine is set to DMX as default.</p> <ul style="list-style-type: none"> In DMX mode: the Fixture accepts DMX control...if in this mode the local DIMMING CONTROL is SET to a level the Light behaviour will follow the HTP (Highest Takes Precedence) modality, in other words it will keep the local DIMMING setting until the DMX level of the specific channel will be higher, from that level onwards the DMX level will take precedence. In this condition if the DMX connection is removed, the light will keep the last level...until power is ON. It will reset and Start at 0 after Power OFF and ON again. In AUTO mode: the light will ignore any DMX control. In this mode any local dimming setting will be maintained and will be automatically recalled after power off, when turning the power on again.

1st MENU Displayed (scrolling with the ▲ and the ▼ buttons)	2nd MENU Displayed (after pressing the X that stands for ENTER)	Explanation of Each MENU FUNCTION
		<p>TEMPERATURE</p> <p>This function Displays in real time the LED ARRAY Case temperature in °C. When pressing Enter again you exit from the temperature display.</p> <p>The steady state TEMPERATURE of the ARRAY reaches approx. 55°C after many hours of continuous operation with an ambient temperature of 25-30°C.</p> <p>The Thermal Handling of the LED is Automatically handled by the local electronics and the LED will operate until the ARRAY temperature reaches 80°C, that anyway is still way within the prescribed maximum nominal prescribed by the ARRAY manufacturer that is 105°C.</p> <p>In case the ARRAY temperature reaches 80°C the unit will automatically turn off.</p> <p>Even in extreme Ambient temperature conditions the LED ARRAY shall never reach the 80°C limit.</p> <p>The above protection threshold is there to protect the LED ARRAY from stressed working conditions in case some other failures or specially critical working conditions are causing an over-temperature.</p>
	   	<p>CHANNEL SETTING (RESOLUTION & FUNCTION)</p> <p>This Function is to set the DIMMING RESOLUTION either at 8 bits or at 16 bits. Once CHAN is displayed, act on the ▲ or ▼ buttons to scroll through the following choices:</p> <ul style="list-style-type: none"> <p>8D: 8 bits resolution (the display will show 8D and this is the default setting). The Fixture utilises 1 DMX Circuit for the Light Dimming, which is the BASE CIRCUIT set in the ADDRESS.</p> <p>8DS: NOT ACTIVE (for future use): <i>The foreseen function for this setting is: 8 bits resolution and STROBE (the display will show 8DS). The Fixture will utilise 2 DMX Circuits, the BASE CIRCUIT set in the ADDRESS will be the LIGHT DIMMING and the second circuit (BASE + 1) will be the STROBE</i></p> <p>16D: 16 bits resolution (the display will show 16D). The Fixture utilises 2 DMX Circuits, the BASE CIRCUIT set in the ADDRESS is the Coarse Dimming, the second Circuit (BASE + 1) is the Fine Dimming.</p> <p>16DS: NOT ACTIVE (for future use): <i>The foreseen function for this setting is: 16 bits resolution and STROBE (the display will show 16DS). The Fixture will utilise 3 DMX Circuits, the BASE CIRCUIT set in the ADDRESS will be the Coarse Dimming, the second Circuit (BASE + 1) will be the Fine Dimming, the third CIRCUIT (BASE + 2) will be the STROBE</i></p> <p>Of course the 16 bits function is useful if the corresponding circuits on the DMX LIGHTING BOARD are also set at 16 bits. WARNING: if the LED FRESNEL is set at 16 bits, but more units are having a consecutive unitary address (for instance first fixture set at Address 1, second fixture set at Address 2 and so forth, the DMX Channel controlling the Coarse Dimming of the second unit, will also control the fine dimming of the first unit. In this case it is recommended that all fixtures are set to 8 bits resolution).</p>
	 	<p>DMX LEVEL</p> <p>It Shows the DMX Input level on percentage (0-99% and FULL) received effectively from the Fixture. Press ENTER to exit this MENU.</p>

6. CHARACTERISTICS AND PERFORMANCE DATA

DESCRIPTION	VALUE	DESCRIPTION	VALUE	
LED Power	160 W	Protection Type	IP 22	
Power Consumption	180W	Max Housing temperature	70 °C	
DMX Data link USITT DMX512-A	<ul style="list-style-type: none"> ➤ This product uses a 5-pin XLR for DMX input and output. Use a shielded data cables. ➤ Do not overload the daisy chain. Up to a maximum of 32 devices can be used on a single DMX chain. 	Weight of Fixture	M.O.	P.O.
			7,8 kg.	9,1 kg.
DMX Channels:	<ul style="list-style-type: none"> ➤ 1 at 8bit: Dimmer ➤ 2 at 16bit: Dimmer 	Weight of barndoor	4 leaf	8 leaf
			0,63 kg.	0,85 kg.
Protection Class	Class 1– ground connection required	Weight of color frame	0,3 kg.	
		Size of scrims & color frame	Seat Diameter	Acc.ies Diameter
			187 mm.	185 mm (7" ¹ / ₄)
		Size of Barndoor ring	Seat Diameter	Ring Diameter
			192 mm.	190 mm (7" ¹ / ₂)
		Lens diameter	175 mm.	

Specifications subject to change without notice.

7. DIMENSIONS

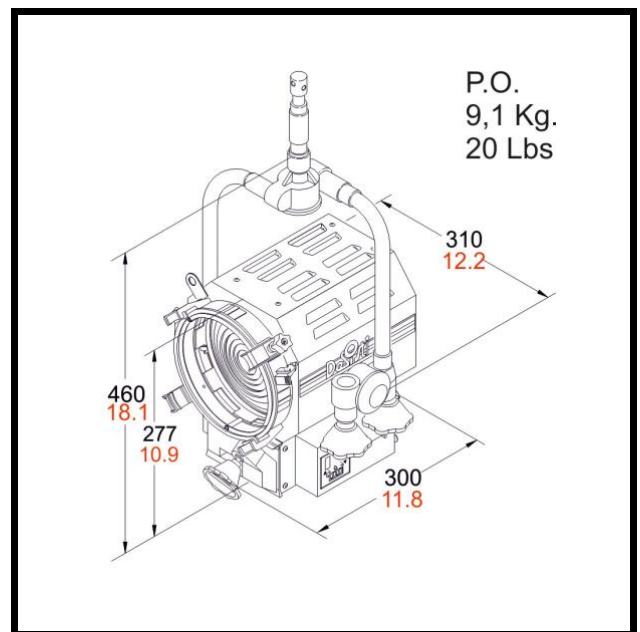
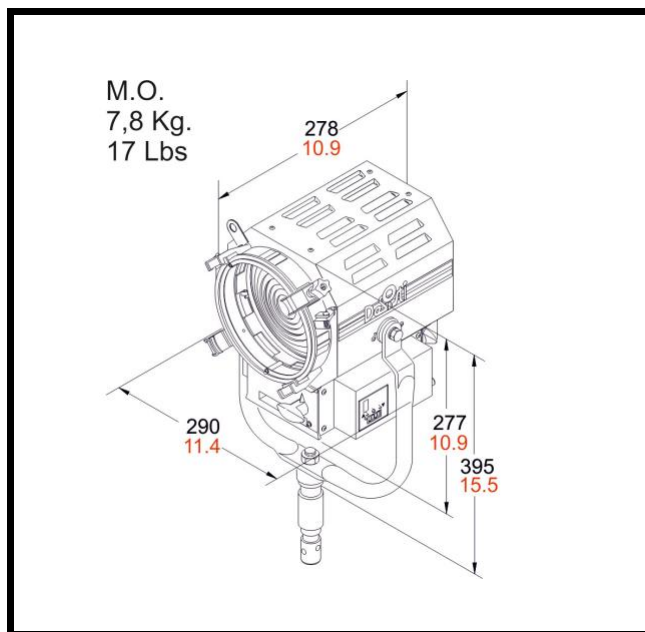

8. PERIODIC INSPECTION & MAINTENANCE

This product requires very little routine maintenance, if any, but has special cleaning instructions: Disconnect fixture from power and allow it to cool for 10 min.

1. Vacuum or gently blow away any dust from fan blades and grills
2. Very gently clean the LED with Isopropyl alcohol.
3. Clean the lenses with a soft damp cloth.
4. Check the condition of the safety shield (see chapter: Installation Instructions) before every use.

5. Check Power supply cable and DMX control cable proper conditions

9. SAFETY STANDARDS

Europe: The product conforms the Applicable European Directives & Standards

- ↻ Low Voltage Directive: **73/23/EEC (as amended by 93/68/EEC)**
- ↻ EMC Directive: **89/336/EEC (as amended by 92/31/EEC & by 93/68/EEC)**
- ↻ European Standards:: **EN 60598-2-17, EN 60598-1 , EN 55015 , EN 61547**

Disposing of this product:

Help preserve the environment! Ensure that this product is recycled at the end of its life.

This product is in compliance with the RoHS and WEEE directives.